

The print-out is not subject to the modification service.

Intended for internal and supplier use

EN

Ⓐ piston rod processing per STAB-Spec. 10028959, table 1

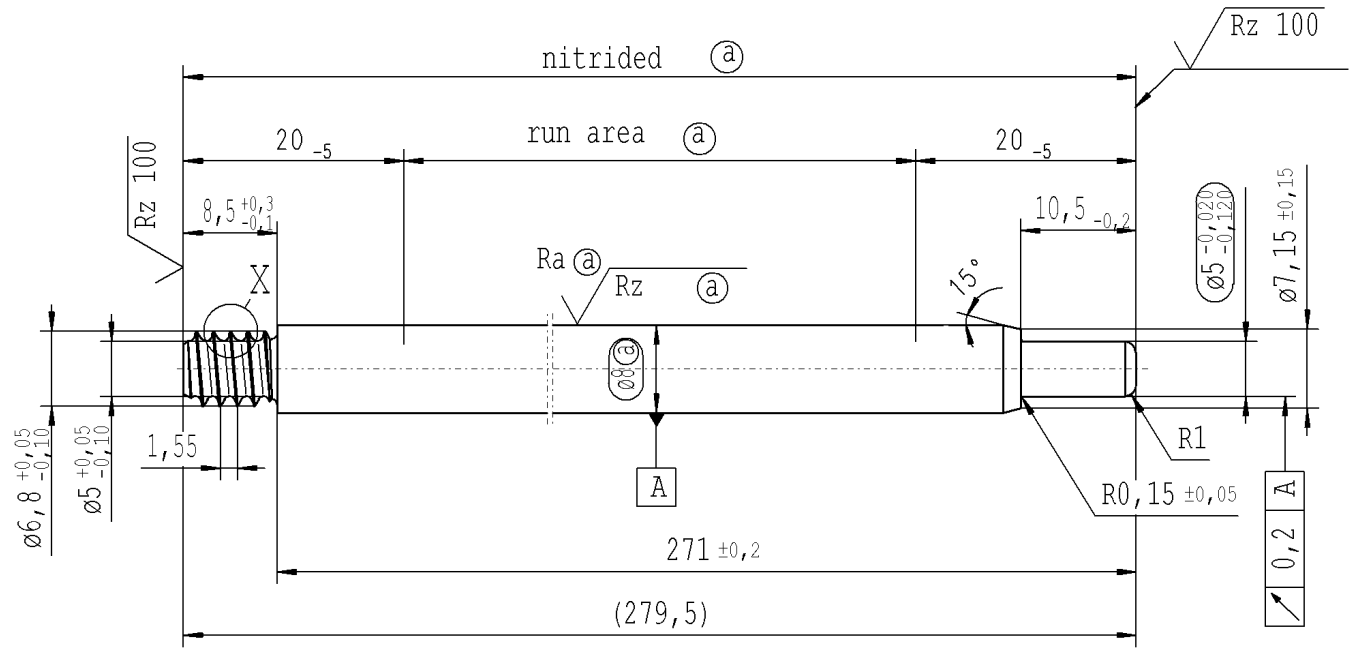

RELEASE
for supplier
company Zhang Shi
14.07.2015 Schilz A.
(date / signature)

pre-worked:

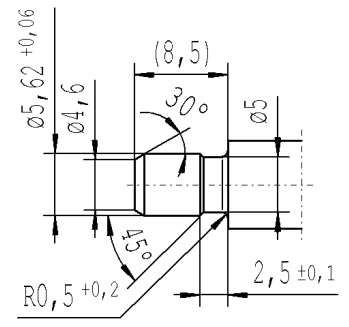

X 5:1

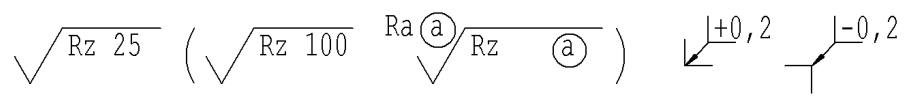
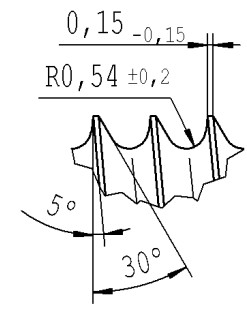

AIAG CQI-standards acc. to STAB-Spec. 10027692

Environmental protection acc. to STAB-Spec. 10005649

DE: X	EN: X	ES:	IT:	PR:	FR:	RO:
new	INITIAL RELEASE	run area				R1
old	-	hardness				0,5x45°
Field	-	F/4,5				E/2
Date/Name	28.05.2008 Hein	02.08.2010, Bo.				13.07.2015 Hein
Chg. No.	-	581802				624057
Rev.	0	1				2

CAD created document; handwritten changes not permitted	
Material:	1.1193 S45C JISG 4051
Edge tolerances acc. to DIN ISO 13715	
Surface finish	DIN EN ISO 1302
Replaces:	
STABILUS	

All dimensions are in mm	Identification of important characteristics
Scale: (Original DIN A3) 2:1	Dimensions without tolerances DIN ISO 2768-mK
We reserve all rights to this document, to any patents or patent registrations related hereto, and to the duplication, retransmission by third parties and misc. use. Any use of this document is not permitted without the written consent of STABILUS.	
PISTON ROD	

Drawn by	Date	Name
Checked		
Document No.:	10151065	
Material No.:	013610	

Ident. Doc.: L62