

The print-out is not subject to the modification service.

Intended for internal and supplier use

EN

Ⓐ piston rod processing per STAB-Spec. 10028959, table 1

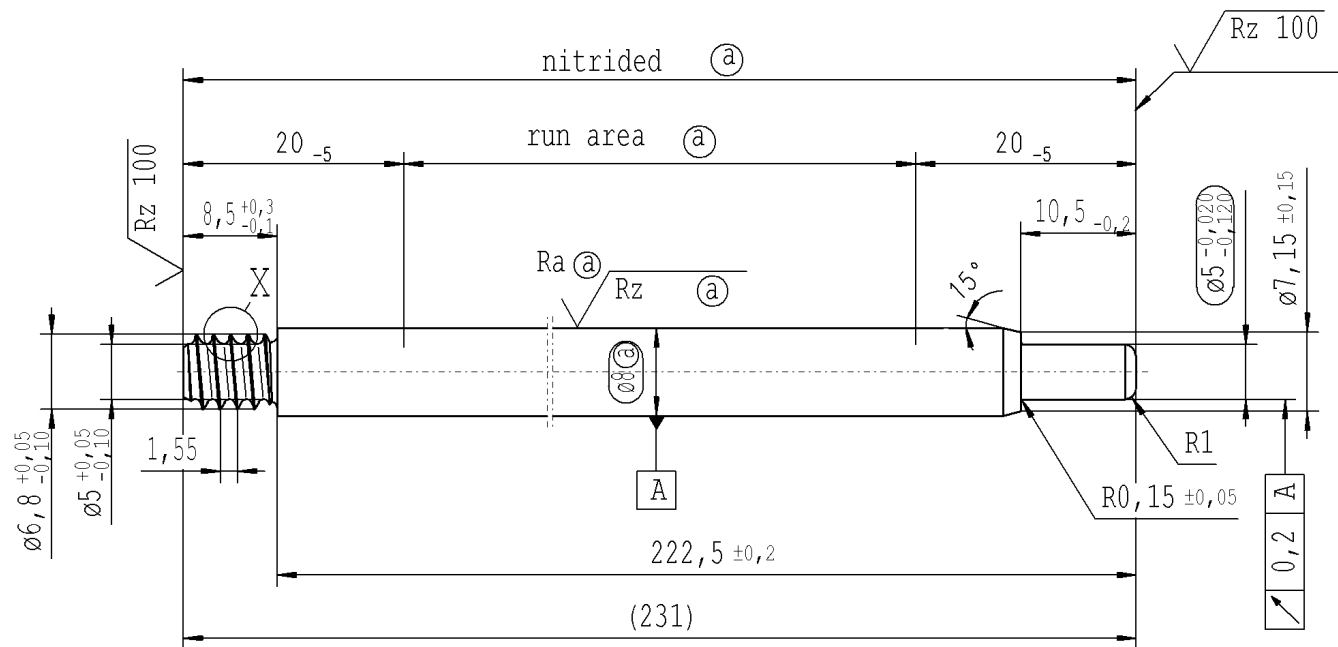

RELEASE
 for supplier
 company Zhang Shi
 14.07.2015 Schilz A.
(date / signature)

pre-worked:

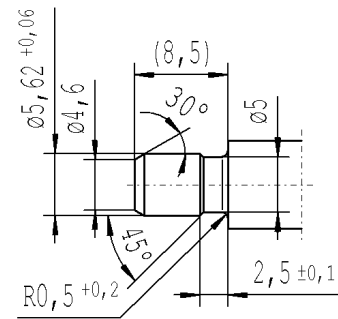

X 5:1

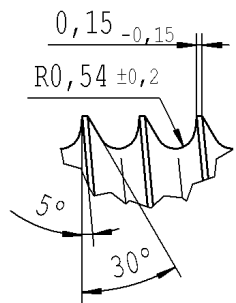

$\sqrt{Rz\ 25}$ ($\sqrt{Rz\ 100}$ $Ra\ \text{Ⓐ}$ $Rz\ \text{Ⓐ}$) $\swarrow +0,2$ $\searrow -0,2$

AIAG CQI-standards acc. to STAB-Spec. 10027692

Environmental protection acc. to STAB-Spec. 10005649

Ident. Doc.: L30

DE: X	EN: X	ES:	IT:	PR:	FR:	RO:
new	INITIAL RELEASE		run area		R1	
old	-		hardness		0,5x45°	
Field	-		F/4,5		E/2	
Date/Name	03.03.2008 K.Marx	28.07.2010 Geisbüsch	13.07.2015 Hein			
Chg. No.	-	581802	624057			
Rev.	0	1	2			

CAD created document; handwritten changes not permitted	
Material:	1.1193 S45C JISG 4051
Edge tolerances acc. to DIN ISO 13715	
Surface finish	DIN ISO 1302
Replaces:	
STABILUS	

All dimensions are in mm	Identification of important characteristics
Scale: (Original DIN A3) 2:1	Dimensions without tolerances DIN ISO 2768 mK
We reserve all rights to this document, to any patents or patent registrations related hereto, and to the duplication, retransmission by third parties and misc. use. Any use of this document is not permitted without the written consent of STABILUS.	
PISTON ROD	

Drawn by	03.03.2008	K.Marx
Checked	13.07.2015	Klinkner
Document No.:	10151065	
Material No.:	005796	